

**“J” TYPE
BARE WIRE LEADS / MALE PLUG (BLACK)**

PART NUMBER	W/MALE PLUG PART NO.	LEAD LENGTH “B”
AJB-48	AJB-48P	48”
AJB-72	AJB-72P	72”
AJB-96	AJB-96P	96”
AJB-120	AJB-120P	120”
AJB-144	AJB-144P	144”

**“K” TYPE
BARE WIRE LEADS / MALE PLUG (YELLOW)**

PART NUMBER	W/MALE PLUG PART NO.	LEAD LENGTH “B”
AJB-48-K	AJB-48P-K	48”
AJB-72-K	AJB-72P-K	72”
AJB-96-K	AJB-96P-K	96”
AJB-120-K	AJB-120P-K	120”
AJB-144-K	AJB-144P-K	144”

SPECIFICATIONS:

- GROUNDED
- STANDARD 3/16” DIAMETER
- MOVABLE THREADED BAYONET CAP
- STAINLESS STEEL OVERBRAID FOR FLEXIBILITY AND DURABILITY

OPTIONS:

- UNGROUNDED
- OTHER DIAMETERS & LENGTHS
- DUAL ELEMENTS

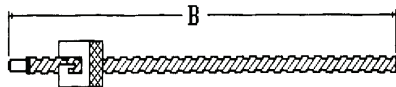

**“J” TYPE
BARE WIRE LEADS / MALE PLUG (BLACK)**

PART NUMBER	W/MALE PLUG PART NO.	LEAD LENGTH “B”
AJH-48	AJH-48P	48”
AJH-72	AJH-72P	72”
AJH-96	AJH-96P	96”
AJH-120	AJH-120P	120”
AJH-144	AJH-144P	144”

**“K” TYPE
BARE WIRE LEADS / MALE PLUG (YELLOW)**

PART NUMBER	W/MALE PLUG PART NO.	LEAD LENGTH “B”
AJH-48-K	AJH-48P-K	48”
AJH-72-K	AJH-72P-K	72”
AJH-96-K	AJH-96P-K	96”
AJH-120-K	AJH-120P-K	120”
AJH-144-K	AJH-144P-K	144”

SPECIFICATIONS:

- GROUNDED
- STANDARD 3/16” DIAMETER
- MOVABLE THREADED BAYONET CAP
- STAINLESS STEEL FLEX HOSE FOR FLEXIBILITY AND DURABILITY

OPTIONS:

- UNGROUNDED
- OTHER DIAMETERS & LENGTHS
- DUAL ELEMENTS

METRIC CAPS AVAILABLE

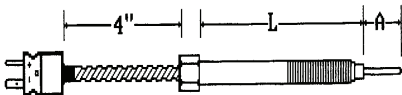

“J” TYPE WITH 4” FLEX HOSE AND MALE PLUG

PART NUMBER	“A” LENGTH	“L” LENGTH
MB-03	Blank	3”
MB-04	Blank	4”
MB-06	Blank	6”
MB-1	Flush	3”
MB-2	1/4”	3”
MB-3	1/2”	3”

PART NUMBER	“A” LENGTH	“L” LENGTH
MB-4	3/4”	3”
MB-5	1”	3”
MB-6	Flush	6”
MB-7	1/4”	6”
MB-8	1/2”	6”
MB-9	3/4”	6”
MB-10	1”	6”

SPECIFICATIONS:

- GROUNDED
- CHOICE OF TIP LENGTH
- CHOICE OF BOLT LENGTH

OPTIONS:

- UNGROUNDED
- OTHER “A” OR “B”

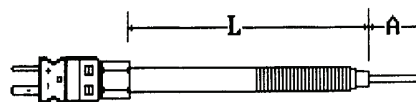

“J” TYPE RIGID

**TEVAC
MELT BOLT THERMOCOUPLES
RIGID TYPE OR FLEXIBLE WITH SS HOSE**

PART NUMBER	“A” LENGTH	“L” LENGTH
MB-21	Flush	3”
MB-22	1/4”	3”
MB-23	1/2”	3”
MB-24	3/4”	3”
MB-25	1”	3”
MB-26	Flush	6”
MB-27	1/4”	6”
MB-28	1/2”	6”
MB-29	3/4”	6”
MB-30	1”	6”



"J" TYPE BARE WIRE / MALE PLUG (BLACK)

PART NUMBER	W/MALE PLUG PART NO.	LEAD LENGTH
ST-48	ST-48P	48"
ST-72	ST-72P	72"
ST-96	ST-96P	96"
ST-120	ST-120P	120"
ST-144	ST-144P	144"

"K" TYPE BARE WIRE / MALE PLUG (BLACK)

PART NUMBER	W/MALE PLUG PART NO.	LEAD LENGTH
ST-48-K	ST-48P-K	48"
ST-72-K	ST-72P-K	72"
ST-96-K	ST-96P-K	96"
ST-120-K	ST-120P-K	120"
ST-144-K	ST-144P-K	144"

**TEVAC
SPADE TYPE THERMOCOUPLES
WITH SS BRAID**

SPECIFICATIONS:

- GROUNDED
- STANDARD 3/4" SQUARE SPADE
- STAINLESS STEEL BRAID FOR FLEXIBILITY

OPTIONS:

- UNGROUNDED
- OTHER SPADE SIZES & LENGTHS



"J" TYPE WITH SS BRAID BARE WIRE/ MALE PLUG (BLACK)

PART NUMBER	LEAD LENGTH	W/MALE PLUG PART NO.	LEAD LENGTH
WT-48	48"	WT-48P	48"
WT-72	72"	WT-72P	72"
WT-96	96"	WT-96P	96"
WT-120	120"	WT-120P	120"
WT-144	144"	WT-144P	144"

"J" TYPE WITH SS FLEX HOSE BARE WIRE/ MALE PLUG (BLACK)

PART NUMBER	LEAD LENGTH	W/MALE PLUG PART NO.	LEAD LENGTH
WT-48H	48"	WT-48H-P	48"
WT-72H	72"	WT-72H-P	72"
WT-96H	96"	WT-96H-P	96"
WT-120H	120"	WT-120H-P	120"
WT-144H	144"	WT-144H-P	144"

**TEVAC
WASHER TYPE THERMOCOUPLES
WITH SS BRAID & HOSE**

SPECIFICATIONS:

- GROUNDED
- **STANDARD #10 LUG (.196)**
- STAINLESS SS BRAID OR FLEX HOSE

OPTIONS:

- "K" TYPE
- UNGROUNDED
- OTHER LUG SIZES & LENGTHS

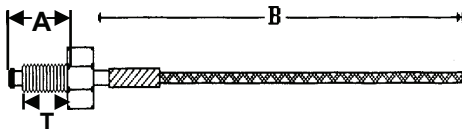

"J" TYPE BARE WIRE / MALE PLUG (BLACK)

PART NUMBER	W/MALE PLUG PART NUMBER	LEAD LENGTH
SN-48	SN-48P	48"
SN-72	SN-72P	72"
SN-96	SN-96P	96"
SN-120	SN-120P	120"
SN-144	SN-144P	144"

"K" TYPE BARE WIRE / MALE PLUG (BLACK)

PART NUMBER	W/MALE PLUG PART NUMBER	LEAD LENGTH
SN-48K	SN-48P-K	48"
SN-72K	SN-72P-K	72"
SN-96K	SN-96P-K	96"
SN-120K	SN-120P-K	120"
SN-144K	SN-144P-K	144"

**TEVAC
SHALLOW NOZZLE THERMOCOUPLES
WITH SS BRAID**

SPECIFICATIONS:

- GROUNDED
- STANDARD 1/2" TIP ("A" LENGTH)
- HEX NUT SWIVELS FREELY
- STANDARD 1/4-28 N.F. THREAD (3/8" "T" LENGTH)

OPTIONS:

- UNGROUNDED
- METRIC THREAD AVAILABLE
- OTHER THREAD SIZES & LENGTHS

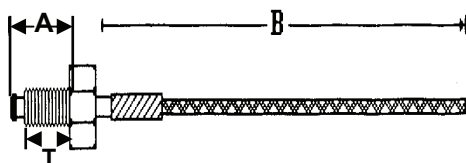

A = 1/2"
T = 3/8"

**TEVAC
METRIC SHALLOW NOZZLE
FITS ALL T/C HOLES FROM 1/2" TO 10" DEEP**

TO ESTABLISH PART NUMBER:

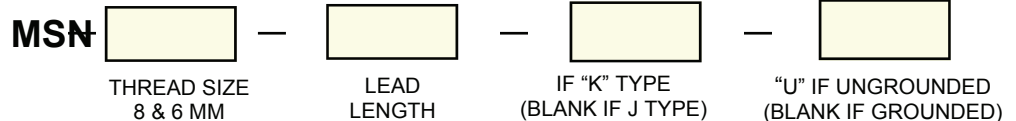

PART NUMBER	DIA. (MM.)	LENGTH "B"
MNT-40-48	40	48"
MNT-40-72	40	72"
MNT-40-144*	40	144"
MNT-50-48	50	48"
MNT-50-72	50	72"
MNT-50-144*	50	144"

SPECIFICATIONS:

- "J" TYPE-STANDARD
- 3/16" WIDE STEEL STRAP
- STAINLESS STEEL BRAID LEADS

* Includes 7ft. Heat Shrink Tube

OPTIONS:

- "K" TYPE
- UNGROUNDED
- OTHER LEAD LENGTHS AVAILABLE
- OTHER NOZZLE DIAMETERS AVAILABLE

**TEVAC
NISSEI METRIC THERMOCOUPLES**

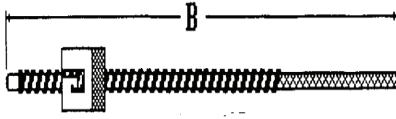
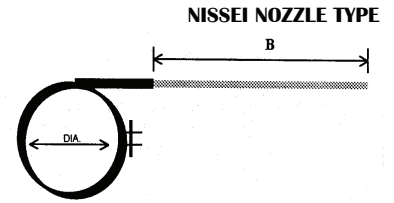

BARE WIRE LEADS / MALE PLUGS

PART NUMBER	LENGTH	WITH PLUG PART NUMBER	LENGTH "B"
MAJB-48	48" BRAID	MAJB-48P	48" BRAID
MAJB-72	72" BRAID	MAJB-72P	72" BRAID

SPECIFICATIONS:

- GROUNDED, "J" TYPE
- MOVEABLE DOUBLE-SLOTTED CAP
- .480" DIAMETER METRIC BAYONET CAP

OPTIONS:

- "K" TYPE
- UNGROUNDED
- LONGER LEAD LENGTHS

**TEVAC
METRIC BAYONET ADAPTORS
FITS ALL T/C HOLES FROM 1/2" TO 10" DEEP**

**TEVAC FIXED DEPTH THERMOCOUPLES
WITH & WITHOUT PLUG**

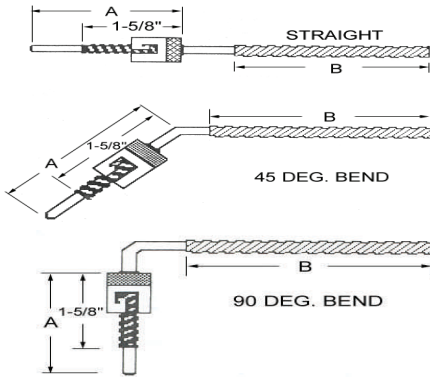

STYLE FDT

STYLE FDT-45

STYLE FDT-90

"J" TYPE WITH **SS HOSE**—NO PLUG
Standard 3/16" Diameter

STYLE TYPE
FDT
FDT-45
FDT-90

"J" TYPE WITH **SS HOSE**—with PLUG
Standard 3/16" Diameter

STYLE TYPE
FDT-*
FDT-45*
FDT-90*

1/4" Diameter available - Specify**
1/8" Diameter available - Specify**

PICTURES SHOWN DO NOT REFLECT "WITH PLUG"

OPTIONS: B-Stainless Steel Braid K-For "K" Type U-For Ungrounded

*ADD "P" TO OPTIONS BOX BELOW FOR MALE PLUG

NOTE: BASE PRICES INCLUDE- UP TO 4" OF "A" LENGTH

TO ESTABLISH PART NUMBER:

STYLE TYPE DIAMETER** (LEAVE) "A" LENGTH "B" LENGTH OPTIONS – SEE ABOVE

EX: Style FDT-90* with plug, with "A" length of 6" & "B" length of 60", "J" Type & Ungrounded would be: **FDT-90-6-60-P-U.**

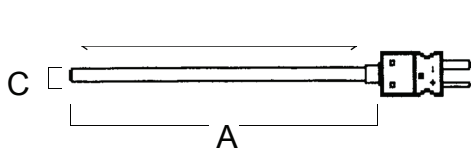

Note: Base Prices for "J" Type ONLY (with Male Plug) & Includes the first 4" of Probe Length

PART NUMBER	DIAMETER (C)
RT-18	1/8"
RT-316	3/16"
RT-14	1/4"

**TEVAC
RIGID TYPE THERMOCOUPLES
WITH MALE PLUG**

OPTIONS: MI-FOR MINERAL INSULATED K-FOR "K" TYPE FJ-FEMALE JACK (REPLACES "P") OR IF NO PLUG OR JACK-DELETE "P"

TO ESTABLISH PART NUMBER:

RT P

DIAMETER (C) MI-FOR MINERAL INSULATED ONLY "A" LENGTH ** OPTIONS

EX: 3/16" Diameter with 9" Probe, "J" Type. Tevac Part No. **RT-316-9-P**

TEVAC COMPRESSION TYPE THERMOCOUPLES WITH & WITHOUT PLUG

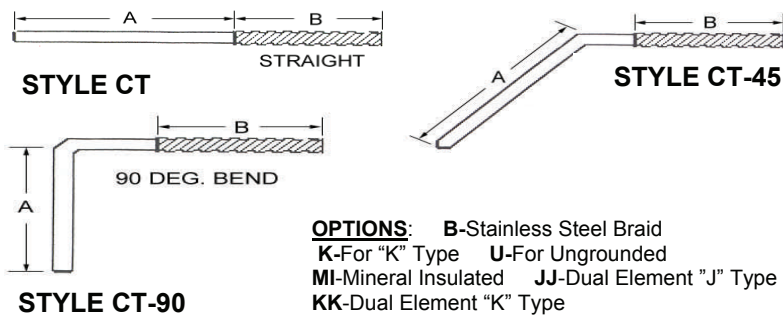

"J" TYPE WITH SS HOSE—NO PLUG
Standard 3/16" Diameter

1/4" Diameter available - Specify**
1/8" Diameter available - Specify**

STYLE TYPE
CT
CT-45
CT-90

"J" TYPE WITH SS HOSE—with PLUG
Standard 3/16" Diameter

STYLE TYPE
CT-*
CT-45*
CT-90*

OPTIONS: B-Stainless Steel Braid
K-For "K" Type U-For Ungrounded
MI-Mineral Insulated JJ-Dual Element "J" Type
KK-Dual Element "K" Type

*ADD "P" TO OPTIONS BOX BELOW FOR MALE PLUG

TO ESTABLISH PART NUMBER:

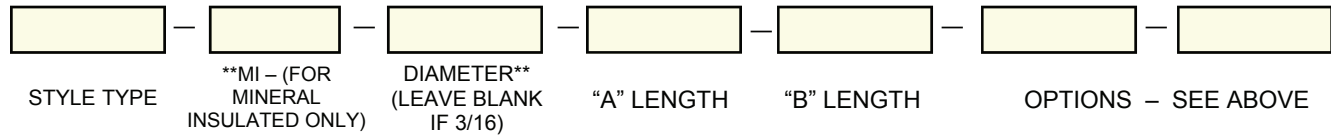

EXAMPLE: Style CT-90* with Plug, with an "A" Length of 6" and a "B" Length of 60", "J" Type, Ungrounded would be: **CT-90-6-60-P-U**

CABLE STYLE

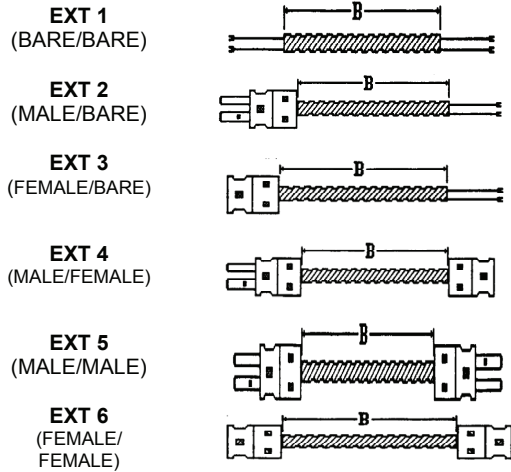

STYLE #
EXT1
EXT2
EXT3
EXT4
EXT5
EXT6

TEVAC EXTENSION CABLES WITH FLEX

BASE PRICES FOR "J" TYPE ONLY & INCLUDE THE FIRST 48" OF HOSE
CALL FOR "K" OR "U" TYPE CABLE

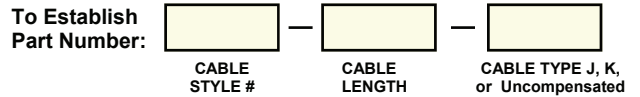

EXAMPLE:
STYLE 5 WITH 72" HOSE, "J" TYPE. PART NO: **EXT5-72-J.**

BAYONET ADAPTORS: STAINLESS STEEL

PART NO.	LENGTH	THREAD
BA-78	7/8"	1/8-27" NPT
BA-78-3	7/8"	3/8-24 NF
BA-150	1-1/2"	1/8-27 NPT
BA-150-3	1-1/2"	3/8-24 NF
BA-200	2"	1/8" NPT
BA-250	2-1/2"	1/8-27NPT
BA-250-3	2-1/2"	3/8-24 NF
BA-350	3-1/2"	1/8-27NPT
BA-350-3	3-1/2"	3/8-24NF

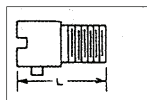

COMPRESSION FITTINGS

Compression fittings slip over tip of thermocouple for mounting and sealing into vessels.

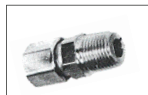

PART NO.	TUBE O.D.	THREAD	MATERIAL
CF-1	1/16"	1/8-27NPT	BRASS
CF-2	1/8"	1/8-27NPT	BRASS
CF-3	3/16"	1/8-27NPT	BRASS
CF-4	1/4"	1/4-18NPT	BRASS

TEVAC THERMOCOUPLE & RTD'S WIRE AND ACCESSORIES

PART NO.	TYPE	COLOR
MP-1	J	Black
MP-1-K	K	Yellow
MP-1-U	U	White

MALE PLUGS

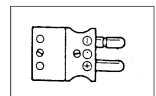

PART NO.	TYPE	COLOR
FJ-2	J	Black
FJ-2-K	K	Yellow
FJ-2-U	U	White

FEMALE JACKS/PLUGS

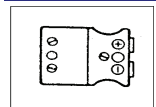

THERMOCOUPLE WIRE

PART NO.	GAUGE	TYPE	WIRE	CONDUCTOR INSULATION	OUTSIDE COVERING
TW-1	20	J	STRANDED	Fiberglass Bd	Fiberglass Bd
TW-2	20	J	STRANDED	Fiberglass Bd	Stainless
TW-3	20	J	SOLID	Teflon	Teflon
TW-4	20	J	SOLID	Fiberglass Bd	Fiberglass Bd
TW-5	20	JX	SOLID	PVC	PVC
TW-6	20	J	STRANDED	Fiberglass (red/white)	None

MINIATURE T/C PLUGS & FEMALE JACKS

PART NO.	TYPE	DESCRIPTION
MMP-1	J	Mini Male Plug
MMP-1-K	K	Mini Male Plug
MFJ-2	J	Mini Female Jack
MFJ-2-K	K	Mini Female Jack

FEMALE JACK PANELS

PART NO.	TYPE	COLOR
FJP-2	J	Black
FJP-2-K	K	Yellow



TEVAC RUNNERLESS MOLDS
HOT RUNNER-MINERAL INSULATED THERMOCOUPLES

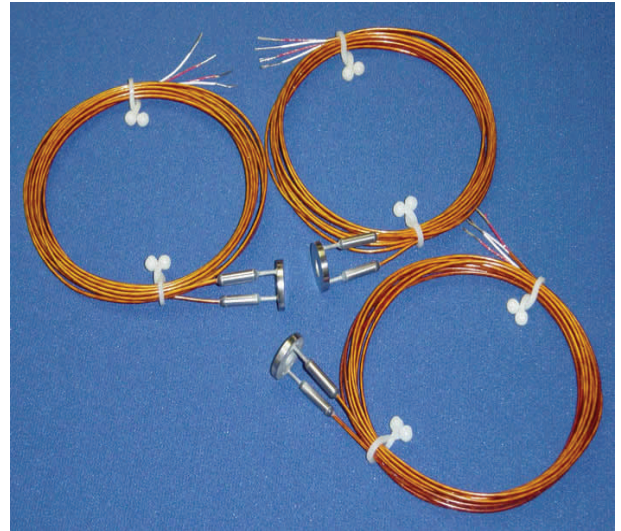
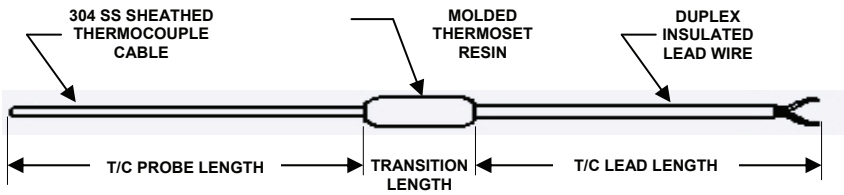

OTHER'S PART NO.
533243
534184
534443
543541
535002
535037
535038
535681
535709
536194
1503163
1503171
2068732

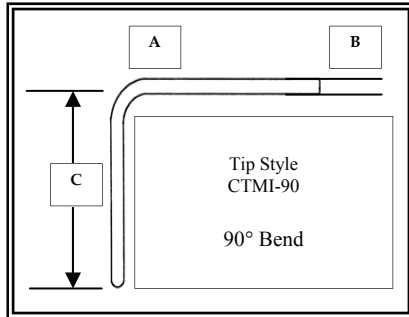

FILL IN BELOW AND CALL, E-MAIL OR FAX FOR PRICE

TEVAC Product Number: CTMI Straight Probe or CTMI90 90° Probe	→		EXAMPLE CTMI90										
Product Diameter: .75mm to 4mm	→		.75 mm										
Probe Length: Straight / "A" : 1" to 18" or 90° / "C" : 1" to 18"	→		C = 2"										
Lead Length: 12" to 240"	→		72"										
Lead Type: Bd = Braid Fb = Fiberglass Tf = Teflon Kp = Kapton	→		Kp										
Calibrations: J = Type J K = Type K T = Type T E = Type E	→		J										
Molded Transitions: <table border="0" style="width: 100%;"> <tr> <td style="border-bottom: 1px solid black;">Probe Diameter:</td> <td style="border-bottom: 1px solid black;">Molded Transition:</td> </tr> <tr> <td>1. .75 MM</td> <td>.165 x .750</td> </tr> <tr> <td>2. 1.0 MM</td> <td>.188 x .750</td> </tr> <tr> <td>3. 1.5 MM</td> <td>.204 x .750</td> </tr> <tr> <td>4. 2.0 MM</td> <td>.250 x .875</td> </tr> </table>	Probe Diameter:	Molded Transition:	1. .75 MM	.165 x .750	2. 1.0 MM	.188 x .750	3. 1.5 MM	.204 x .750	4. 2.0 MM	.250 x .875	→		2
Probe Diameter:	Molded Transition:												
1. .75 MM	.165 x .750												
2. 1.0 MM	.188 x .750												
3. 1.5 MM	.204 x .750												
4. 2.0 MM	.250 x .875												
Junction/Other: G = Ground U = Ungrounded P = Plug	→		G										

TEVAC will cross reference other manufacturer's part numbers for you!
OEM QUALITY!
QUICK QUOTES on your Custom Items! Specialty Items in just days!

Color-Codes have been adopted by various national and international standard agencies for the identification of thermocouple wire and products.
 In the United States, thermocouple grade wire normally has a brown overall jacket. For Types B, R and S the color-codes relate to the compensating cable normally used.

T/C Type	UNITED STATES ANSI 96.1	UNITED KINGDOM BS 1843	WEST GERMANY DIN 43714	JAPAN JIS C1610-1981	FRANCE NF C42-323
B	GREY + GREY - RED	----	GREY + RED - GREY	GREY + RED - WHITE	----
E	PURPLE + PURPLE - RED	BROWN + BROWN - BLUE	BLACK + RED - BLACK	PURPLE + RED - WHITE	----
J	BLACK + WHITE - RED	BLACK + YELLOW - BLUE	BLUE + RED - BLUE	YELLOW + RED - WHITE	BLACK + YELLOW - BLACK
K	YELLOW + YELLOW - RED	RED + BROWN - BLUE	GREEN + RED - GREEN	BLUE + RED - WHITE	YELLOW + YELLOW - PURPLE
N	ORANGE + ORANGE - RED	----	----	----	----
R	GREEN + BLACK - RED	GREEN + WHITE - BLUE	----	BLACK + RED - WHITE	----
S	GREEN + BLACK - RED	GREEN + WHITE - BLUE	WHITE + RED - WHITE	BLACK + RED - WHITE	GREEN + YELLOW - GREEN
T	BLUE + BLUE - RED	BLUE + WHITE - BLUE	BROWN + RED - BROWN	BROWN + RED - WHITE	BLUE + YELLOW - BLUE

High Quality & Your Best Value

**QUALITY THERMOCOUPLES
 KEEP YOUR MACHINES RUNNING
 & YOU IN BUSINESS!**

*The cost of LOST PRODUCTION
 due to an inferior thermocouple
 is much higher than the cost of
Tevac's Quality Thermocouples*

Hundreds of Standard Thermocouples
 in a Wide Variety on our shelves Right Now!
 Fast Delivery on
Custom Thermocouples
 to suit YOUR needs –
Call TEVAC Now for a Quick Quote!

SPECIALS ARE OUR SPECIALTY !

Need a custom or non-stock
RTD in a hurry?

Ask about our **RUSH** delivery service!

SEE OUR **THERMOCOUPLES** FOR STYLES AND
OPTIONS, THEN ADD "RTD" AS A PREFIX AND CONTACT
TEVAC FOR PRICING!

EXAMPLE:
RTD-WT-60-P (for a Washer Type RTD with 60" Braid & Plug)

STANDARD 7-10 DAY DELIVERY

BASIC ORDERING INFORMATION:

- ◆ RTD TYPE (Adjustable, Fixed Depth, etc.)
- ◆ DIAMETER (3/16", 1/8", 1/4" etc.)
- ◆ CALIBRATION TYPE (100 OHM, Euro Curve, etc.)
- ◆ TIP/PROBE LENGTH (if applicable)
- ◆ THREAD SIZE (1/4-28, 8mm, etc. if applicable)
- ◆ LEAD LENGTH (12" increments)
- ◆ LEAD COVERING (SS Braid, Hose, etc.)
- ◆ TERMINATION TYPE (Bare wires, plug, etc.)
- ◆ OPTIONS NEEDED (Ungrounded, etc.)
- ◆ QUANTITY NEEDED
- ◆ DATE NEEDED

STILL NOT SURE ?

**SEND US A SAMPLE OR DRAWING &
WE'LL DO THE REST !**

CONTACT TEVAC TODAY