

IN STOCK!

**TEVAC SPRUE BUSHINGS
HARDENED, GROUND, & PRECISION**

$O = 5/32, 7/32, 9/32, \text{ or } 11/32$
 $R = 1/2 \text{ or } 3/4$

TEVAC'S Sprue Bushings are available in a wide variety of types. These off-the shelf standards allow the mold to be used in a variety of injection molding machines.

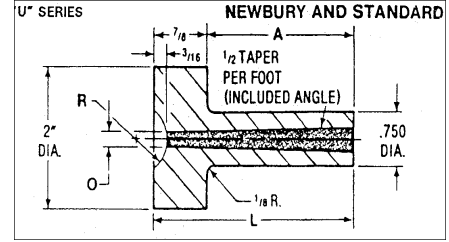
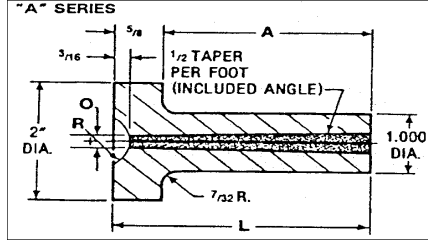
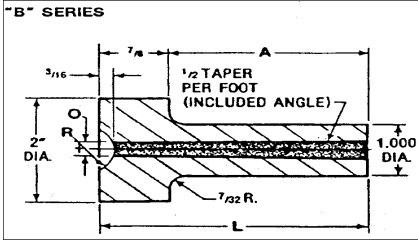

Part Number	A	L
SBB-1-	29/32	1-25/32
SBB-2-	1-13/32	2-9/32
SBB-3-	1-29/32	2-25/32
SBB-4-	2-13/32	3-9/32
SBB-5-	2-29/32	3-25/32
SBB-6-	3-13/32	4-9/32
SBB-7-	3-29/32	4-25/32
SBB-8-	4-13/32	5-9/32
SBB-9-	4-29/32	5-25/32
SBB-10-	5-29/32	6-25/32
SBB-11-	6-29/32	7-25/32

Part Number	A	L
SBA-1-	1-3/16	1-13/16
SBA-2-	1-11/16	2-5/16
SBA-3-	2-3/16	2-13/16
SBA-4-	2-11/16	3-5/16
SBA-5-	3-3/16	3-13/16
SBA-6-	3-11/16	4-5/16
SBA-7-	4-3/16	4-13/16

Part Number	A	L
SBU-1-	29/32	1-25/32
SBU-2-	1-13/32	2-9/32
SBU-3-	1-29/32	2-25/32
SBU-4-	2-13/32	3-9/32
SBU-5-	2-29/32	3-25/32

$O = 5/32, 7/32, 9/32, \text{ or } 11/32$
 $R = 1/2 \text{ or } 3/4$

$O = 5/32, 7/32, \text{ or } 9/32$
 $R = 1/2 \text{ or } 3/4$

For Correct Product, order by Part No., followed by "O" Size, then "R". Example: SBB-1-0532-R12

TEVAC SPACER

O.D.	D	T	SCREW SIZE	TEVAC PART NUMBER
1/2"	11/16"	3/16	10-24	SP-050
3/4"	1"	3/16	1/4-20	SP-075
1"	1-3/16"	3/16	1/4-20	SP-100
1-1/2"	1-11/16"	1/4	5/16-18	SP-150
2"	2-3/16"	1/4	5/16-18	SP-200

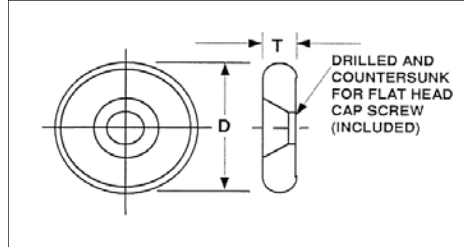

**TEVAC
REPLACEMENT O-RINGS**

Tevac Part Number
OR-1/8
OR-1/4
OR-3/8
OR-1/2

STOP PINS

TEVAC PART NUMBER
SP-1
SP-2

5/8" Head Diam.
Straight Stem
SP-1

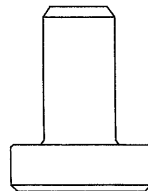

100 PCS
200+ PCS

5/8" Head Diam.
Self Tapping
SP-2

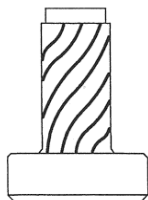

NEW ITEM

TEVAC PART NUMBER
SB-200

1-99 PCS
100 PCS
500 PCS
1000 PCS

TEVAC STOP BUTTONS

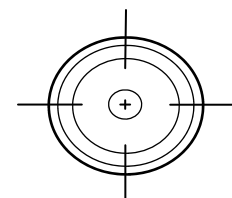
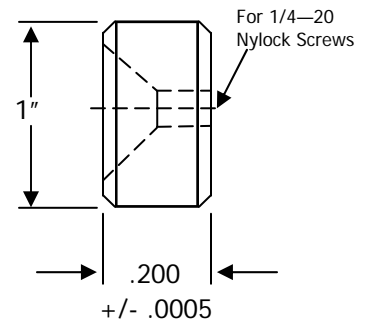

*Includes:
1/4-20 Nylock Hex Screws